

DrayTek

Vigor2862 Series

VDSL2 Security Firewall



Quick Start Guide (Wired Model)

V1.8

Vigor2862 Series VDSL2 Security Firewall Quick Start Guide (for Wired Model)

Version: 1.8

Firmware Version: V3.9.5

(For future update, please visit [DrayTek web site](http://www.draytek.com))

Date: January 20, 2021

Intellectual Property Rights (IPR) Information

Copyrights

© All rights reserved. This publication contains information that is protected by copyright. No part may be reproduced, transmitted, transcribed, stored in a retrieval system, or translated into any language without written permission from the copyright holders.

Trademarks

The following trademarks are used in this document:

- Microsoft is a registered trademark of Microsoft Corp.
- Windows 7, 8, 10 and Explorer are trademarks of Microsoft Corp.
- Apple and Mac OS are registered trademarks of Apple Inc.
- Other products may be trademarks or registered trademarks of their respective manufacturers.

Safety Instructions and Approval

Safety Instructions

- Read the installation guide thoroughly before you set up the router.
- The router is a complicated electronic unit that may be repaired only by authorized and qualified personnel. Do not try to open or repair the router yourself.
- Do not place the router in a damp or humid place, e.g. a bathroom.
- Do not stack the routers.
- The router should be used in a sheltered area, within a temperature range of +5 to +40 Celsius.
- Do not expose the router to direct sunlight or other heat sources. The housing and electronic components may be damaged by direct sunlight or heat sources.
- Do not deploy the cable for LAN connection outdoor to prevent electronic shock hazards.
- Keep the package out of reach of children.
- When you want to dispose of the router, please follow local regulations on conservation of the environment.

Warranty

We warrant to the original end user (purchaser) that the router will be free from any defects in workmanship or materials for a period of two (2) years from the date of purchase from the dealer. Please keep your purchase receipt in a safe place as it serves as proof of date of purchase. During the warranty period, and upon proof of purchase, should the product have indications of failure due to faulty workmanship and/or materials, we will, at our discretion, repair or replace the defective products or components, without charge for either parts or labor, to whatever extent we deem necessary to restore the product to proper operating condition. Any replacement will consist of a new or re-manufactured functionally equivalent product of equal value, and will be offered solely at our discretion. This warranty will not apply if the product is modified, misused, tampered with, damaged by an act of God, or subjected to abnormal working conditions. The warranty does not cover the bundled or licensed software of other vendors. Defects which do not significantly affect the usability of the product will not be covered by the warranty. We reserve the right to revise the manual and online documentation and to make changes from time to time in the contents hereof without obligation to notify any person of such revision or changes.



EU Declaration of Conformity

We DrayTek Corp. , office at No.26, FuShing Road, HuKou, HsinChu Industrial Park, Hsinchu 303, Taiwan , R.O.C., declare under our sole responsibility that the product

- **Product name:** VDSL2 Security Firewall
- **Model number:** Vigor2862, Vigor2862B
- **Manufacturer:** DrayTek Corp.
- **Address:** No.26, Fushing Rd., Hukou, Hsinchu Industrial Park, Hsinchu 303, Taiwan

is in conformity with the relevant Union harmonisation legislation:

EMC Directive 2014/30/EU , Low Voltage Directive 2014/35/EU , ErP 2009/125/EC and RoHS 2011/65/EU with reference to the following standards

Standard	Version / Issue date
EN 55032	2012+AC:2013 class B
EN 61000-3-2	2014 Class A
EN 61000-3-3	2013
EN 55024	2010+A1:2015
EN 60950-1	2006 +A11:2009 +A1:2010 +A12:2011+ A2:2013
EC No. 1275/2008	2008

Hsinchu
(place)

22nd June, 2017
(date)

Calvin Ma
Calvin Ma / President
(Legal Signature)



Regulatory Information

Federal Communication Commission Interference Statement

This equipment has been tested and found to comply with the limits for a Class B digital device, pursuant to Part 15 of the FCC Rules. These limits are designed to provide reasonable protection against harmful interference in a residential installation. This equipment generates, uses and can radiate radio frequency energy and, if not installed and used in accordance with the instructions, may cause harmful interference to radio communications. However, there is no guarantee that interference will not occur in a particular installation. If this equipment does cause harmful interference to radio or television reception, which can be determined by turning the equipment off and on, the user is encouraged to try to correct the interference by one of the following measures:

- Reorient or relocate the receiving antenna.
- Increase the separation between the equipment and receiver.
- Connect the equipment into an outlet on a circuit different from that to which the receiver is connected.
- Consult the dealer or an experienced radio/TV technician for help.

This device complies with Part 15 of the FCC Rules. Operation is subject to the following two conditions:

- (1) This device may not cause harmful interference, and
- (2) This device may accept any interference received, including interference that may cause undesired operation.

Caution: Any changes or modifications not expressly approved by the party responsible for compliance could void the user's authority to operate the equipment.

The antenna/transmitter should be kept at least 20 cm away from human body.

DrayTek Vigor2862 series VDSL2/ADSL2+ routers are compliant with 47 C.F.R. Part 68.



More update, please visit www.draytek.com.

Table of Contents

1. Introduction.....	1
2. Package Content	2
3. Panel Explanation.....	3
3.1 Vigor2862/Vigor2862B	3
3.2 Notes for Y Cable Application.....	5
4. Hardware Installation	6
4.1 Network Connection	6
4.2 Wall-Mounted Installation	7
5. Software Configuration	8
5.1 Quick Start Wizard for Network Connection.....	8
6. Customer Service	14
Be a Registered Owner	14
Firmware & Tools Updates	14

1. Introduction

Vigor2862/2862B is a VDSL2 router with multi-subnet for secure and efficient workgroup management. It integrates IP layer QoS, NAT session/bandwidth management to help users control works well with large bandwidth.

By adopting hardware-based VPN platform and hardware encryption of AES/DES/3DES, and hardware key hash of SHA-1/MD5, the router increases the performance of VPN greatly and offers several protocols (such as IPSec/PPTP/L2TP) with up to 32 VPN tunnels.

The object-based design used in SPI (Stateful Packet Inspection) firewall allows users to set firewall policy with ease. CSM (Content Security Management) provides users control and management in IM (Instant Messenger) and P2P (Peer to Peer) more efficiency than before. In addition, DoS/DDoS prevention and URL/Web content filter strengthen the security outside and control inside.

Vigor2862/2862B supports USB interface for connecting USB printer to share printing function, 3G/4G USB modem for network connection, connectivity for network FTP service, or thermometer for monitoring the temperature change.

Vigor2862B can enhance the transmission rate and enlarge the bandwidth by combining two standard VDSL2 lines, thus it is able to provide low line prices instead of expensive leased lines. Meanwhile, the speed of existing connection established for customers can be increased.

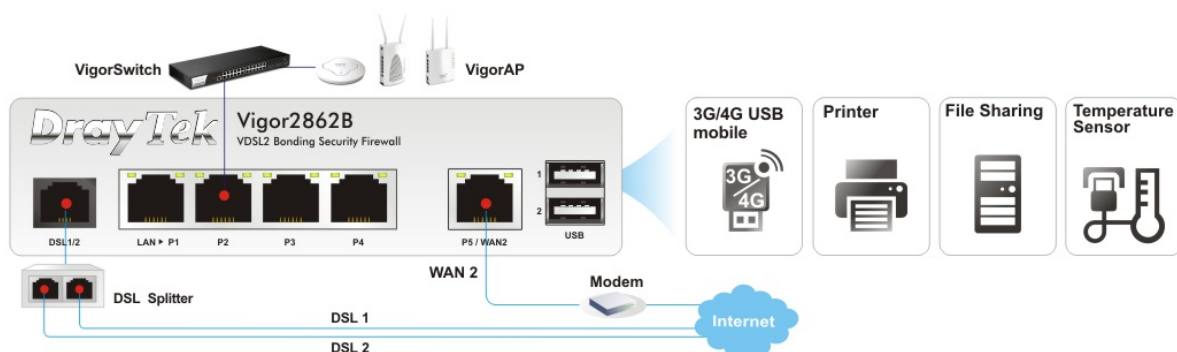

2. Package Content

Take a look at the package content. If there is anything missed or damaged, please contact DrayTek or dealer immediately.



Vigor Router

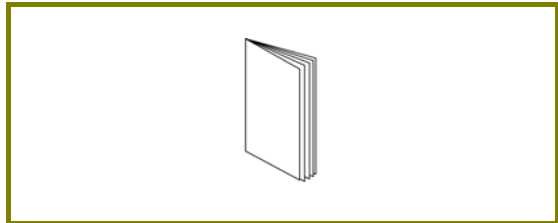

Quick Start Guide

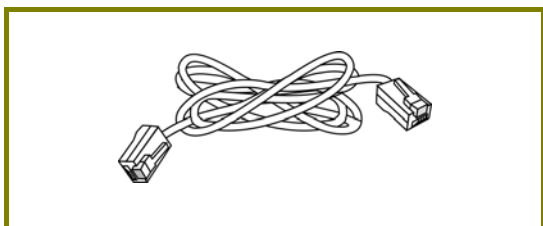

**RJ-45 to RJ-45 Cable
(Annex B)**

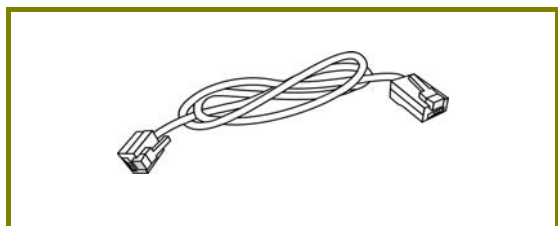

**RJ-11 to RJ-45 Cable (Annex B)
RJ-11 to RJ-11 Cable (Annex A)**

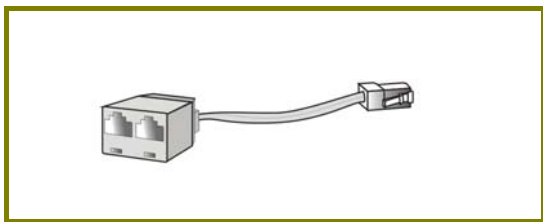

Y Cable (B models)

The type of the power adapter depends on the country that the router will be installed. * The maximum power consumption is *30 Watt*.

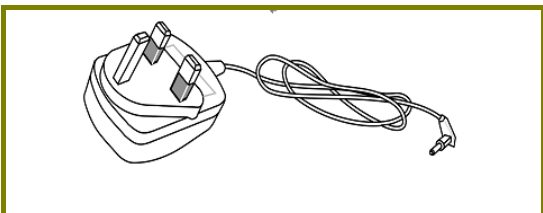

UK-type Power Adapter

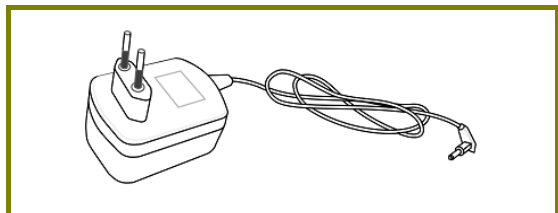

EU-type Power Adapter

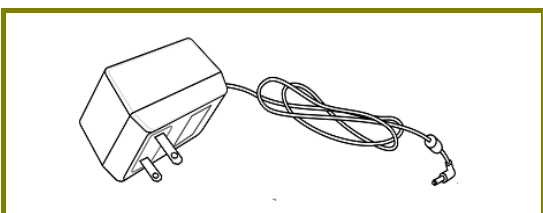

USA/Taiwan-type Power Adapter

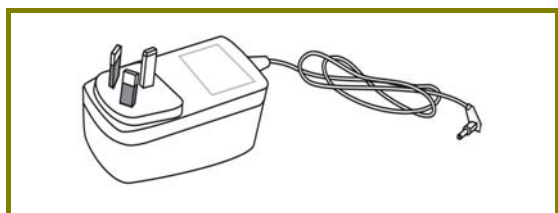

AU/NZ-type Power Adapter

3. Panel Explanation

3.1 Vigor2862/Vigor2862B

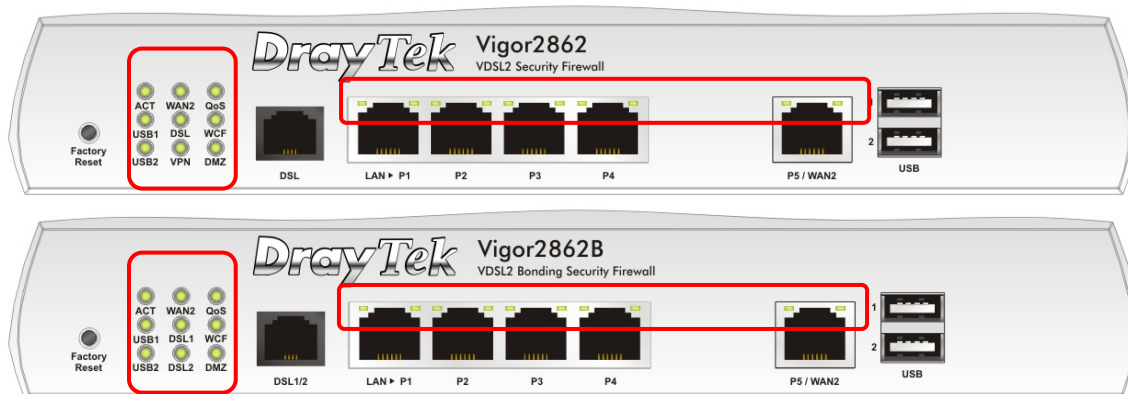

LED	Status	Explanation	
ACT (Activity)	Off	The router is powered off.	
	Blinking	The router is powered on and running normally.	
WAN2	On	Internet connection is ready.	
	Off	Internet connection is not ready.	
	Blinking	The data is transmitting.	
QoS	On	The QoS function is active.	
	Off	The QoS function is inactive.	
USB1~2 / USB	On	USB device is connected and ready for use.	
	Off	No USB device is connected.	
	Blinking	The data is transmitting.	
DSL/DSL 1/2	On	The router is ready to access Internet through DSL link.	
	Blinking	Slowly: The DSL connection is ready. Quickly: The connection is training.	
WCF	On	The Web Content Filter is active. (It is enabled from Firewall >> General Setup).	
	Off	WCF is disabled.	
VPN	On	The VPN tunnel is active.	
	Off	VPN services are disabled	
	Blinking	Traffic is passing through VPN tunnel.	
DMZ	On	The DMZ function is enabled.	
	Off	The DMZ function is disabled.	
	Blinking	The data is transmitting.	
LED on Connector			
LAN P1~P4	Left LED	On	The port is connected.
		Off	The port is disconnected.
		Blinking	The data is transmitting.
	Right	On	The port is connected with 1000Mbps.

	LED	Off	The port is connected with 10/100Mbps
P5 / WAN2	Left LED	On	The port is connected.
		Off	The port is disconnected.
		Blinking	The data is transmitting.
	Right LED	On	The port is connected with 1000Mbps.
		Off	The port is connected with 10/100Mbps

The port "P5 / WAN2" is switchable. It can be used for LAN connection or WAN connection according to the settings configured in WUI.

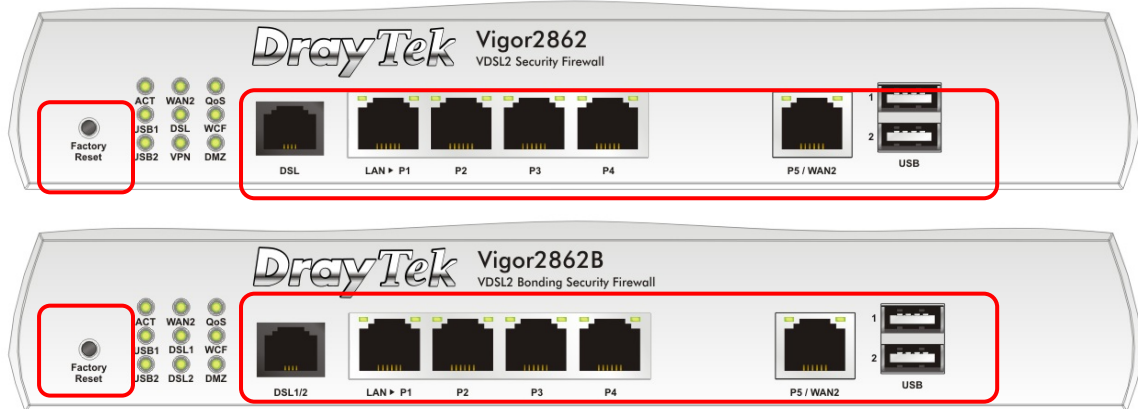

Switch on Rear Side

Interface	Description
Factory Reset	Restore the default settings. Usage: Turn on the router (ACT LED is blinking). Press the hole and keep for more than 5 seconds. When you see the ACT LED begins to blink rapidly than usual, release the button. Then the router will restart with the factory default configuration.
DSL / DSL 1/2	Connector for accessing the Internet.
LAN P1-P4	Connectors for local network devices.
P5 / WAN2	Connector for local network devices or modem for accessing Internet.
USB1~2	Connector for a USB device (for 3G/4G USB Modem or printer or thermometer).
PWR	Connector for a power adapter.
ON/OFF	Power Switch.

3.2 Notes for Y Cable Application

Y cable is prepared for the one who applies bonding VDSL service (two lines or one line) to ISP for enhancing the transmission rate and enlarging the bandwidth.

However, the following conditions shall be considered first while installing the DSL line(s) on to Vigor router.

Condition 1: When the bonding VDSL service offered by ISP contains two separate cables, please insert the Y cable to the DSL1/2 connector of Vigor router first. Then, connect the two VDSL cables to dual-connector marked with 1 and 2 on Y cable.

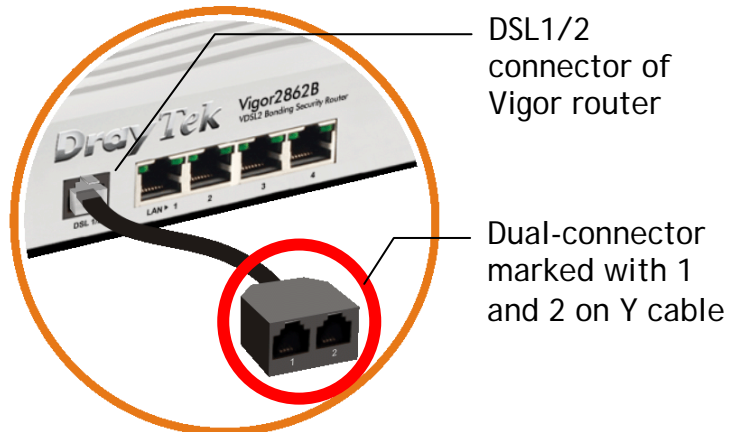

Condition 2: When the bonding VDSL service offered by ISP contains only one cable (contains two VDSL lines), simply connect it to the DSL1/2 connector of Vigor router.



Condition 3: However, when the user purchased bonding VDSL router (e.g., B models) but did not apply for bonding VDSL service from local ISP, the Y cable should be inserted to the DSL1/2 connector of Vigor router first. Later, connect the VDSL cable (contains one VDSL line) to the dual-connector marked with 1 to reduce the unnecessary signal interference and reduce the time of signal detection.

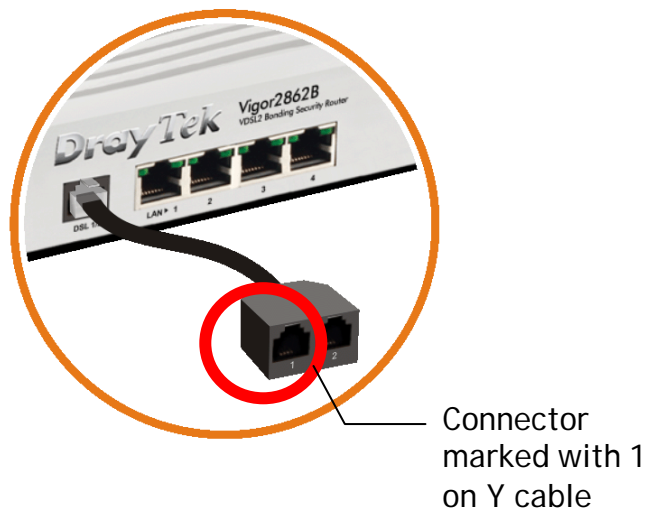

4. Hardware Installation

This section will guide you to install the router through hardware connection and configure the router's settings through web browser.

Before starting to configure the router, you have to connect your devices correctly.

4.1 Network Connection

1. Connect the DSL interface to the land line jack with a DSL line cable, or Connect the cable Modem/DSL Modem/Media Converter to the WAN port of router with Ethernet cable (RJ-45).
2. Connect one end of an Ethernet cable (RJ-45) to one of the LAN ports of the router and the other end of the cable (RJ-45) into the Ethernet port on your computer.
3. Connect one end of the power adapter to the router's power port on the rear panel, and the other side into a wall outlet.
4. Power on the device by pressing down the power switch on the rear panel.
5. The system starts to initiate. After completing the system test, the **ACT** LED will light up and start blinking. (For the detailed information of LED status, please refer to section 3. Panel Explanation)

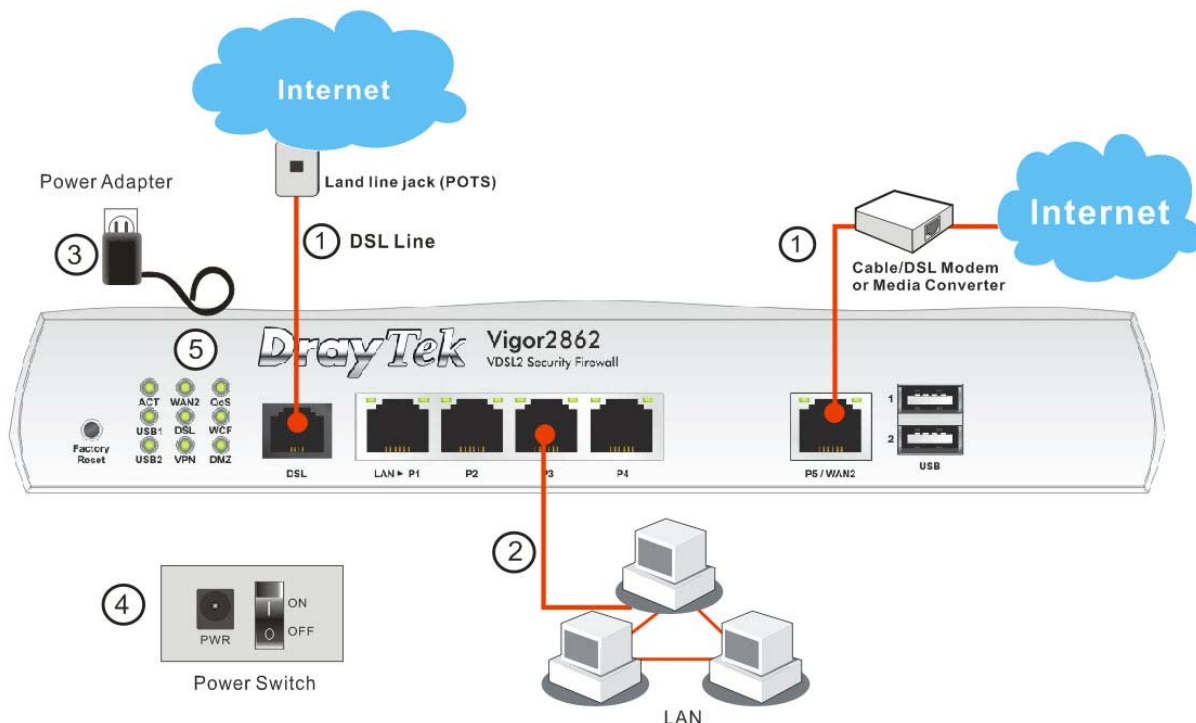

4.2 Wall-Mounted Installation

Vigor router has keyhole type mounting slots on the underside.

1. Drill two holes on the wall. The distance between the holes shall be 168mm.
2. Fit screws into the wall using the appropriate type of wall plug.

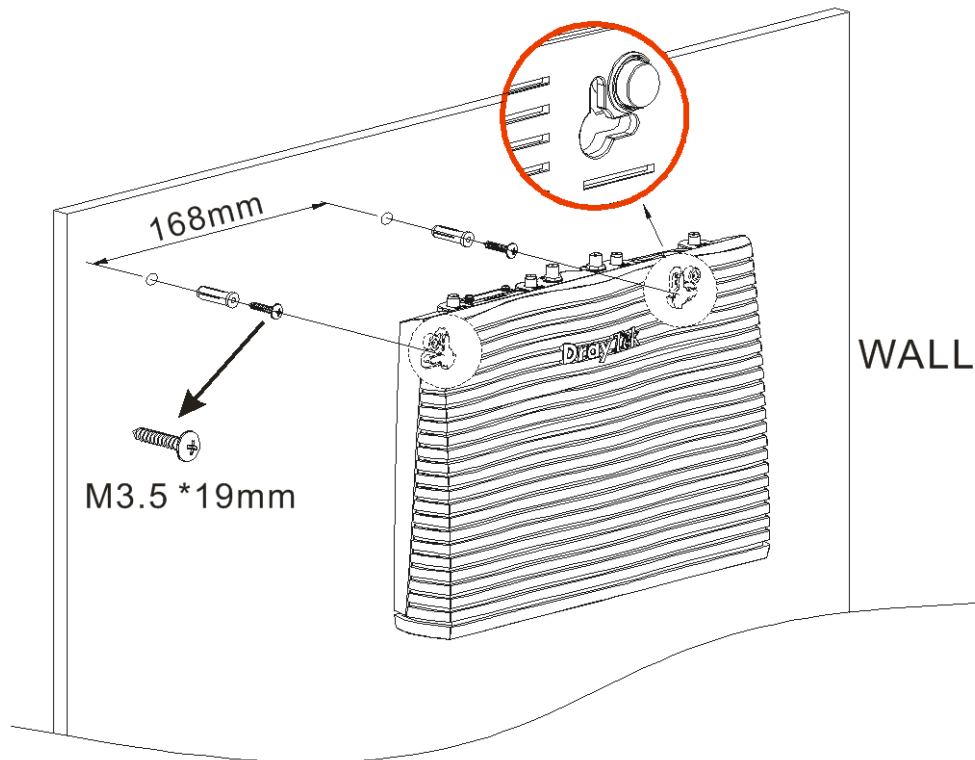

Note

The recommended drill diameter shall be 6.5mm (1/4").

3. When you finished about procedure, the router has been mounted on the wall firmly.

5. Software Configuration

To access Internet, please finish basic configuration after completing the hardware installation.

5.1 Quick Start Wizard for Network Connection

The **Quick Start Wizard** is designed for you to easily set up your router for Internet access. You can directly access the **Quick Start Wizard** via Web Configurator. Make sure your PC connects to the router correctly.



Note

You may either simply set up your computer to get IP dynamically from the router or set up the IP address of the computer to be the same subnet as the **default IP address of Vigor router 192.168.1.1**. For the detailed information, please refer to - Trouble Shooting of the user's guide.

Open a web browser on your PC and type **http://192.168.1.1**. A pop-up window will open to ask for username and password. Please type "admin/admin" as the Username/Password and click **Login**.



Note

If you fail to access to the web configuration, please go to "Trouble Shooting" on User's Guide for detecting and solving your problem.

Now, the Main Screen will pop up. Click **Wizards>>Quick Start Wizard**.

DrayTek Vigor2862 Series

Auto Logout | IP6

Wizards

Dashboard

System Information

Model Name	Vigor2862	System Up Time	0:00:39
Router Name	DrayTek	Current Time	2000 Jan 1 Sat 0:0:33
Firmware Version	3.8.8	Build Date/Time	May 18 2017 03:05:00
DSL Version	07-07-06-0D-00-07	LAN MAC Address	00-1D-AA-F7-C0-F0

IPv4 LAN Information

LAN	IP Address	DHCP	LAN	IP Address	DHCP
LAN1	192.168.1.1/24	v	LAN2	192.168.2.1/24	v
LAN3	192.168.3.1/24	v	LAN4	192.168.4.1/24	v
LAN5	192.168.5.1/24	v	LAN6	192.168.6.1/24	v
LAN7	192.168.7.1/24	v	LAN8	192.168.8.1/24	v
DMZ PORT	192.168.17.1/24	v	IP Routed Subnet	192.168.0.1/24	v

IPv4 Internet Access

WAN	Line / Mode	IP Address	MAC Address	Up Time
WAN1	ADSL / ---	Disconnected	00-1D-AA-F7-C0-F1	00:00:00
WAN2	Ethernet / DHCP Client	Disconnected	00-1D-AA-F7-C0-F2	00:00:00
WAN3	USB / ---	Disconnected	00-1D-AA-F7-C0-F3	00:00:00
WAN4	USB / ---	Disconnected	00-1D-AA-F7-C0-F4	00:00:00

Interface

DSL	Connected : Down Stream : 0kbps / Up Stream : 0kbps
WAN	Connected : 0, WAN1 WAN2 WAN3 WAN4
LAN	Connected : 0, Port1 Port2 Port3 Port4

Quick Access

- System Status
- Dynamic DNS
- TR069
- User Management
- IM/P2P Block
- Schedule
- SysLog / Mail Alert
- LDAP
- RADIUS
- Firewall Object
- Setting
- Data Flow Monitor



Note

The home page will change slightly in accordance with the router you have.

If your router can be under an environment with high speed NAT, the configuration provide here can help you to deploy and use the router quickly. The first screen of **Quick Start Wizard** is entering login password. After typing the password, please click **Next**.

Quick Start Wizard

Enter login password

Please enter an alpha-numeric string as your **Password** (Max 23 characters).

Old Password

New Password

Confirm Password

< Back Next > Finish Cancel

On the next page as shown below, please select the WAN interface that you use. If DSL interface is used, please choose WAN1; if Ethernet interface is used, please choose WAN2; if 3G USB modem is used, please choose WAN3 or WAN4. Then click **Next** for next step. WAN1, WAN2, WAN3 and WAN4 will bring up different configuration page. Here, we take WAN1 (ADSL/VDSL2) as an example.

Quick Start Wizard

WAN Interface

WAN Interface:	WAN1
Display Name:	
Physical Mode:	ADSL / VDSL2
Physical Type:	Auto negotiation
VLAN Tag insertion (ADSL):	Disable
VLAN Tag insertion (VDSL2):	Disable

< Back Next > Finish Cancel

Click **Next** to go to the following page. You have to select the appropriate Internet access type according to the information from your ISP. For example, you should select PPPoE mode if the ISP provides you PPPoE interface. In addition, the field of **For ADSL Only** will be available only when ADSL is detected. Then click **Next** for next step.

Quick Start Wizard

Connect to Internet

WAN 1	
Protocol	MPoA / Static or Dynamic IP
For ADSL Only:	
Encapsulation	1483 Bridged IP LLC
VPI	0 Auto detect
VCI	88
Fixed IP	<input checked="" type="radio"/> Yes <input type="radio"/> No(Dynamic IP)
IP Address	192.16.20.86
Subnet Mask	255.255.255.0
Default Gateway	192.16.20.1
Primary DNS	8.8.4.4
Second DNS	168.95.192.1

< Back Next > Finish Cancel

PPPoE/PPPoA

1. Choose WAN1 as WAN Interface and click the Next button; you will get the following page.

Quick Start Wizard

Connect to Internet

WAN 1	
Protocol	PPPoE / PPPoA
For ADSL Only:	
Encapsulation	PPPoE LLC/SNAP
VPI	0 <input type="button" value="Auto detect"/>
VCI	88
Fixed IP	<input checked="" type="radio"/> Yes <input type="radio"/> No(Dynamic IP)
IP Address	192.16.20.86
Subnet Mask	255.255.255.0
Default Gateway	192.16.20.1
Primary DNS	8.8.4.4
Second DNS	168.95.192.1

2. After finished the above settings, simply click Next.

Quick Start Wizard

Set PPPoE / PPPoA

WAN 1	
Service Name (Optional)	CHTI
Username	77494727@hinet.net
Password	*****
Confirm Password	*****

3. Please manually enter the Username/Password provided by your ISP. Then click Next for viewing summary of such connection.

Quick Start Wizard

Please confirm your settings:

WAN Interface:	WAN1
Physical Mode:	ADSL / VDSL2
VPI:	0
VCI:	33
Protocol / Encapsulation:	PPPoE / LLC
Fixed IP:	No
Primary DNS:	8.8.8.8
Secondary DNS:	8.8.4.4

< Back

Next >

Finish

Cancel

4. Click **Finish**. A page of **Quick Start Wizard Setup OK!!!** will appear. Then, the system status of this protocol will be shown.
5. Now, you can enjoy surfing on the Internet.

MPoA / Static or Dynamic IP

1. Choose WAN1 as WAN Interface and click the Next button; you will get the following page.

Quick Start Wizard

Connect to Internet

WAN 1

Protocol: MPoA / Static or Dynamic IP

For ADSL Only:

Encapsulation: 1483 Bridged IP LLC

VPI: 0

VCI: 88

Fixed IP: Yes No(Dynamic IP)

IP Address: 192.16.20.86

Subnet Mask: 255.255.255.0

Default Gateway: 192.16.20.1

Primary DNS: 8.8.4.4

Second DNS: 168.95.192.1

2. Please type in the IP address/mask/gateway information originally provided by your ISP. Then click Next for viewing summary of such connection.

Quick Start Wizard

Please confirm your settings:

WAN Interface: WAN1

Physical Mode: ADSL / VDSL2

VPI: 0

VCI: 33

Protocol / Encapsulation: 1483 Route LLC

Fixed IP: No

Primary DNS: 8.8.8.8

Secondary DNS: 8.8.4.4

3. Click Finish. A page of Quick Start Wizard Setup OK!!! will appear. Then, the system status of this protocol will be shown.
4. Now, you can enjoy surfing on the Internet.

6. Customer Service

If the router cannot work correctly after trying many efforts, please contact your dealer for further help right away. For any questions, please feel free to send e-mail to support@draytek.com.

Be a Registered Owner

Web registration is preferred. You can register your Vigor router via <https://myvigor.draytek.com>.

Firmware & Tools Updates

Due to the continuous evolution of DrayTek technology, all routers will be regularly upgraded. Please consult the DrayTek web site for more information on newest firmware, tools and documents. <https://www.draytek.com>